

LM78XX Series Voltage Regulators

General Description

The LM78XX series of three terminal regulators is available with several fixed output voltages making them useful in a wide range of applications. One of these is local on card regulation, eliminating the distribution problems associated with single point regulation. The voltages available allow these regulators to be used in logic systems, instrumentation, HiFi, and other solid state electronic equipment. Although designed primarily as fixed voltage regulators these devices can be used with external components to obtain adjustable voltages and currents.

The LM78XX series is available in an aluminum TO-3 package which will allow over 1.0A load current if adequate heat sinking is provided. Current limiting is included to limit the peak output current to a safe value. Safe area protection for the output transistor is provided to limit internal power dissipation. If internal power dissipation becomes too high for the heat sinking provided, the thermal shutdown circuit takes over preventing the IC from overheating.

Considerable effort was expanded to make the LM78XX series of regulators easy to use and minimize the number

of external components. It is not necessary to bypass the output, although this does improve transient response. Input bypassing is needed only if the regulator is located far from the filter capacitor of the power supply.

For output voltage other than 5V, 12V and 15V the LM117 series provides an output voltage range from 1.2V to 57V.

Features

- Output current in excess of 1A
- Internal thermal overload protection
- No external components required
- Output transistor safe area protection
- Internal short circuit current limit
- Available in the aluminum TO-3 package

Voltage Range

LM7805C	5V
LM7812C	12V
LM7815C	15V

Schematic and Connection Diagrams

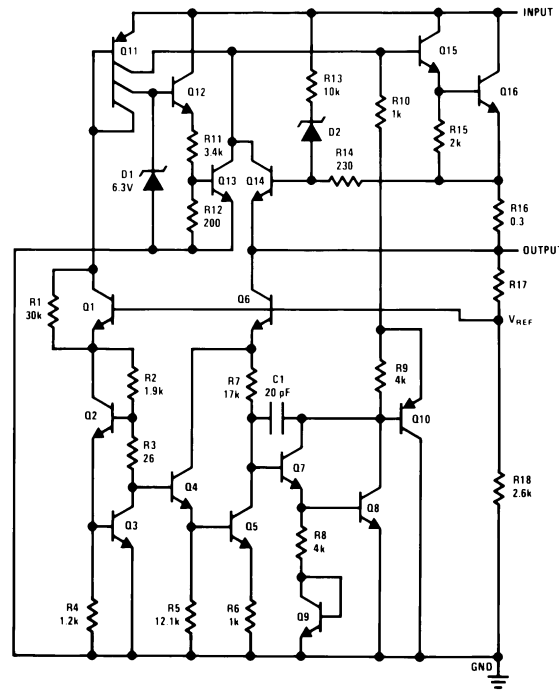

TL/H/7746-1

**Metal Can Package
TO-3 (K)
Aluminum**

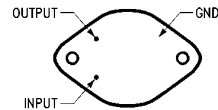

TL/H/7746-2

Bottom View

**Order Number LM7805CK,
LM7812CK or LM7815CK
See NS Package Number KC02A**

**Plastic Package
TO-220 (T)**

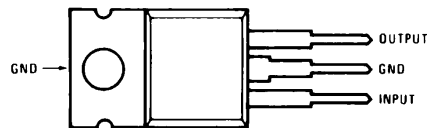

TL/H/7746-3

Top View

**Order Number LM7805CT,
LM7812CT or LM7815CT
See NS Package Number T03B**

Absolute Maximum Ratings

If Military/Aerospace specified devices are required, please contact the National Semiconductor Sales Office/Distributors for availability and specifications.

Input Voltage ($V_O = 5V, 12V$ and $15V$) 35V
 Internal Power Dissipation (Note 1) Internally Limited
 Operating Temperature Range (T_A) 0°C to $+70^\circ\text{C}$

Maximum Junction Temperature
 (K Package) 150°C
 (T Package) 150°C
 Storage Temperature Range -65°C to $+150^\circ\text{C}$
 Lead Temperature (Soldering, 10 sec.)
 TO-3 Package K 300°C
 TO-220 Package T 230°C

Electrical Characteristics LM78XXC (Note 2) $0^\circ\text{C} \leq T_j \leq 125^\circ\text{C}$ unless otherwise noted.

Output Voltage			5V			12V			15V			Units	
Input Voltage (unless otherwise noted)			10V			19V			23V				
Symbol	Parameter	Conditions	Min	Typ	Max	Min	Typ	Max	Min	Typ	Max		
V_O	Output Voltage	$T_j = 25^\circ\text{C}, 5\text{ mA} \leq I_O \leq 1\text{ A}$	4.8	5	5.2	11.5	12	12.5	14.4	15	15.6	V	
		$P_D \leq 15\text{ W}, 5\text{ mA} \leq I_O \leq 1\text{ A}$	4.75		5.25	11.4		12.6	14.25		15.75	V	
		$V_{\text{MIN}} \leq V_{\text{IN}} \leq V_{\text{MAX}}$	(7.5 $\leq V_{\text{IN}} \leq 20$)			(14.5 $\leq V_{\text{IN}} \leq 27$)			(17.5 $\leq V_{\text{IN}} \leq 30$)			V	
ΔV_O	Line Regulation	$I_O = 500\text{ mA}$	$T_j = 25^\circ\text{C}$	3	50	4	120	4	150			mV	
			ΔV_{IN}	(7 $\leq V_{\text{IN}} \leq 25$)			(14.5 $\leq V_{\text{IN}} \leq 30$)			(17.5 $\leq V_{\text{IN}} \leq 30$)		V	
			$0^\circ\text{C} \leq T_j \leq +125^\circ\text{C}$		50		120		150			mV	
		$I_O \leq 1\text{ A}$	ΔV_{IN}	(8 $\leq V_{\text{IN}} \leq 20$)			(15 $\leq V_{\text{IN}} \leq 27$)			(18.5 $\leq V_{\text{IN}} \leq 30$)		V	
			$T_j = 25^\circ\text{C}$		50		120		150			mV	
			ΔV_{IN}	(7.5 $\leq V_{\text{IN}} \leq 20$)			(14.6 $\leq V_{\text{IN}} \leq 27$)			(17.7 $\leq V_{\text{IN}} \leq 30$)		V	
ΔV_O	Load Regulation	$T_j = 25^\circ\text{C}$	$5\text{ mA} \leq I_O \leq 1.5\text{ A}$	10	50	12	120	12	150			mV	
			$250\text{ mA} \leq I_O \leq 750\text{ mA}$		25		60		75			mV	
		$5\text{ mA} \leq I_O \leq 1\text{ A}, 0^\circ\text{C} \leq T_j \leq +125^\circ\text{C}$		50		120		150			mV		
I_Q	Quiescent Current	$I_O \leq 1\text{ A}$	$T_j = 25^\circ\text{C}$		8		8		8			mA	
			$0^\circ\text{C} \leq T_j \leq +125^\circ\text{C}$		8.5		8.5		8.5			mA	
ΔI_Q	Quiescent Current Change	$5\text{ mA} \leq I_O \leq 1\text{ A}$			0.5		0.5		0.5			mA	
			$T_j = 25^\circ\text{C}, I_O \leq 1\text{ A}$		1.0		1.0		1.0			mA	
			$V_{\text{MIN}} \leq V_{\text{IN}} \leq V_{\text{MAX}}$	(7.5 $\leq V_{\text{IN}} \leq 20$)			(14.8 $\leq V_{\text{IN}} \leq 27$)			(17.9 $\leq V_{\text{IN}} \leq 30$)		V	
V_N	Output Noise Voltage	$T_A = 25^\circ\text{C}, 10\text{ Hz} \leq f \leq 100\text{ kHz}$		40		75		90				μV	
			$\frac{\Delta V_{\text{IN}}}{\Delta V_{\text{OUT}}}$	Ripple Rejection	$f = 120\text{ Hz} \left\{ \begin{array}{l} I_O \leq 1\text{ A}, T_j = 25^\circ\text{C} \text{ or} \\ I_O \leq 500\text{ mA} \\ 0^\circ\text{C} \leq T_j \leq +125^\circ\text{C} \end{array} \right.$	62	80	55	72	54	70		dB
						62		55		54			dB
R_O	Dropout Voltage Output Resistance Short-Circuit Current Peak Output Current Average TC of V_{OUT}	$T_j = 25^\circ\text{C}, I_{\text{OUT}} = 1\text{ A}$ $f = 1\text{ kHz}$ $T_j = 25^\circ\text{C}$ $T_j = 25^\circ\text{C}$ $0^\circ\text{C} \leq T_j \leq +125^\circ\text{C}, I_O = 5\text{ mA}$		2.0		2.0		2.0				V	
					8		18		19			m Ω	
					2.1		1.5		1.2			A	
					2.4		2.4		2.4			A	
					0.6		1.5		1.8			mV/ $^\circ\text{C}$	
V_{IN}	Input Voltage Required to Maintain Line Regulation	$T_j = 25^\circ\text{C}, I_O \leq 1\text{ A}$		7.5		14.6		17.7				V	

Note 1: Thermal resistance of the TO-3 package (K, KC) is typically $4^\circ\text{C}/\text{W}$ junction to case and $35^\circ\text{C}/\text{W}$ case to ambient. Thermal resistance of the TO-220 package (T) is typically $4^\circ\text{C}/\text{W}$ junction to case and $50^\circ\text{C}/\text{W}$ case to ambient.

Note 2: All characteristics are measured with capacitor across the input of $0.22\ \mu\text{F}$, and a capacitor across the output of $0.1\ \mu\text{F}$. All characteristics except noise voltage and ripple rejection ratio are measured using pulse techniques ($t_w \leq 10\text{ ms}$, duty cycle $\leq 5\%$). Output voltage changes due to changes in internal temperature must be taken into account separately.

Typical Performance Characteristics

Maximum Average Power Dissipation

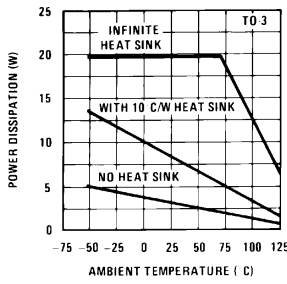

Maximum Average Power Dissipation

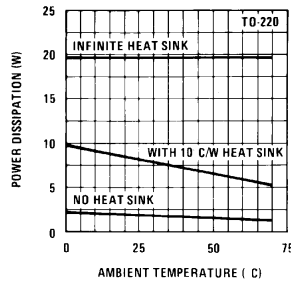

Peak Output Current

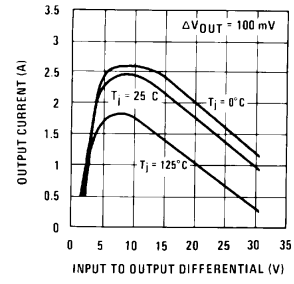

Output Voltage (Normalized to 1V at $T_j = 25^\circ\text{C}$)

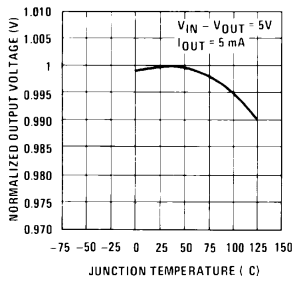

Ripple Rejection

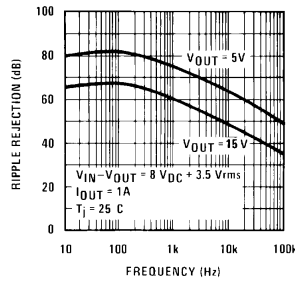

Ripple Rejection

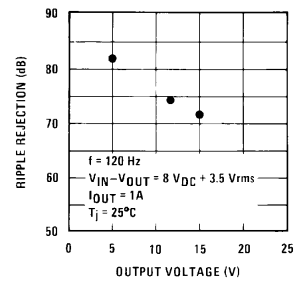

Output Impedance

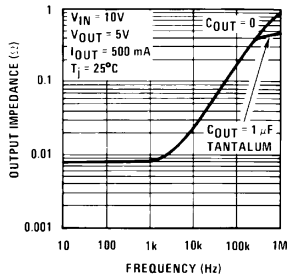

Dropout Voltage

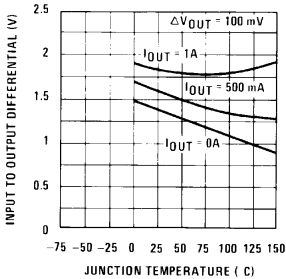

Dropout Characteristics

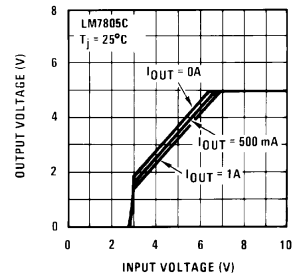

Quiescent Current

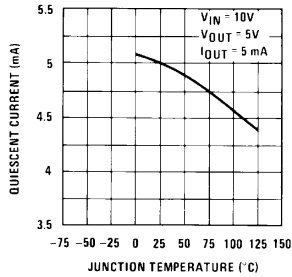

Quiescent Current

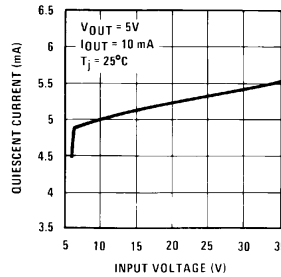



Physical Dimensions inches (millimeters)

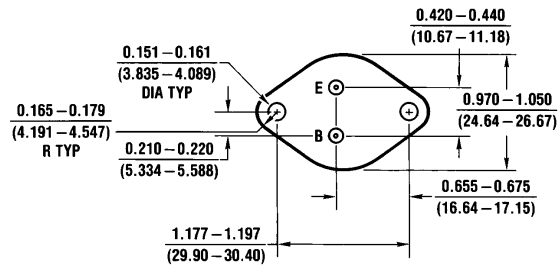
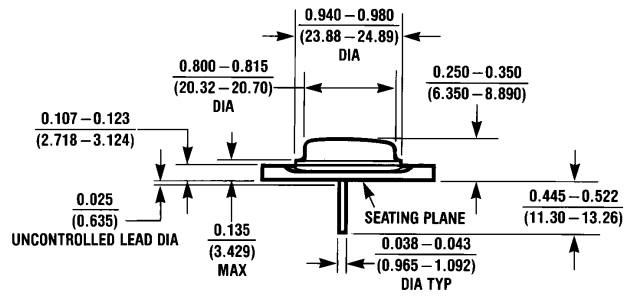

KC02A (REV C)

Aluminum Metal Can Package (KC)
Order Number LM7805CK, LM7812CK or LM7815CK
NS Package Number KC02A

Physical Dimensions inches (millimeters) (Continued)

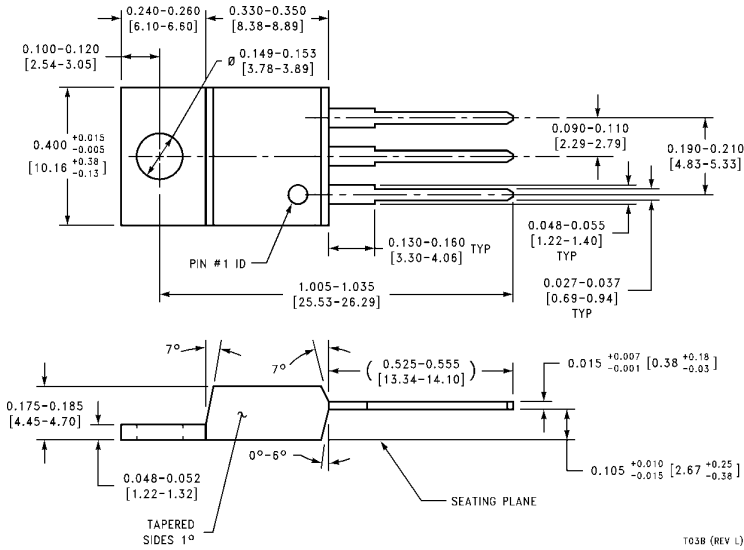

TO-220 Package (T)
Order Number LM7805CT, LM7812CT or LM7815CT
NS Package Number T03B

LIFE SUPPORT POLICY

NATIONAL'S PRODUCTS ARE NOT AUTHORIZED FOR USE AS CRITICAL COMPONENTS IN LIFE SUPPORT DEVICES OR SYSTEMS WITHOUT THE EXPRESS WRITTEN APPROVAL OF THE PRESIDENT OF NATIONAL SEMICONDUCTOR CORPORATION. As used herein:

1. Life support devices or systems are devices or systems which, (a) are intended for surgical implant into the body, or (b) support or sustain life, and whose failure to perform, when properly used in accordance with instructions for use provided in the labeling, can be reasonably expected to result in a significant injury to the user.
2. A critical component is any component of a life support device or system whose failure to perform can be reasonably expected to cause the failure of the life support device or system, or to affect its safety or effectiveness.



National Semiconductor Corporation
 1111 West Bardin Road
 Arlington, TX 76017
 Tel: 1(800) 272-9959
 Fax: 1(800) 737-7018

National Semiconductor Europe
 Fax: (+49) 0-180-530 85 86
 Email: cnjwge@tevm2.nsc.com
 Deutsch Tel: (+49) 0-180-530 85 85
 English Tel: (+49) 0-180-532 78 32
 Français Tel: (+49) 0-180-532 93 58
 Italiano Tel: (+49) 0-180-534 16 80

National Semiconductor Hong Kong Ltd.
 19th Floor, Straight Block,
 Ocean Centre, 5 Canton Rd.
 Tsimshatsui, Kowloon
 Hong Kong
 Tel: (852) 2737-1600
 Fax: (852) 2736-9960

National Semiconductor Japan Ltd.
 Tel: 81-043-299-2309
 Fax: 81-043-299-2408

National does not assume any responsibility for use of any circuitry described, no circuit patent licenses are implied and National reserves the right at any time without notice to change said circuitry and specifications.